

IMAGEN

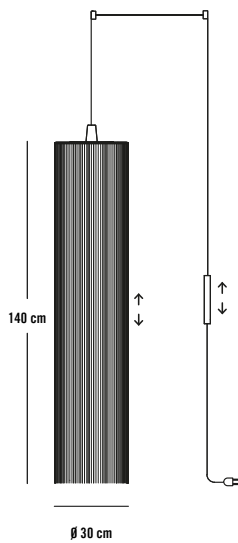

* Modelos 9004 y 9014

COTAS GENERALES



ACABADOS



MANTENIMIENTO

Limpiar con un paño suave. No utilizar productos amoniacales, disolventes o abrasivos.

DESCRIPCIÓN

Lámpara de suspensión regulable en altura a través de un contrapeso metálico acabado en cromo negro o pintado blanco brillante. Compuesta por hilos en tejido de algodón en ocho colores. Imprevisibles juegos de luces y sombras, Swing crea ambientes de glamour e intimidad.

ESPECIFICACIONES GENERALES

Montaje	Techo
Ambiente	Interior
IP	20

MATERIALES

Cuerpo	Acero
Pantalla	Hilo de algodón

ACABADOS

Acero	Cromo Negro, Blanco brillante
Hilo algodón	Blanco, Negro, Rojo, Verde, Gris claro, Violeta, Marrón, Crema

CARACTERÍSTICAS ELÉCTRICAS

Clase de aislamiento	Clase I
Tipo fuente de luz	LED
Tipo LED	E27
Potencia total	1 x 7W
Temperatura de color	2700K
Voltaje AC	220-240v
Frecuencia	50-60Hz
Regulación (<i>Sujeto a bombilla* regulable</i>)	TRIAC (<i>corde de fase</i>) DALI bajo pedido

* Bombilla no incluida



DIMENSIONES Y EMBALAJE

Cuerpo	Ø30x140cm
Longitud de cable	8,5m

Medida bulto	40x40x40cm
Volumen bulto	0,192m ³
Peso bulto	5,7g

IMAGE



* Modelos 9004 y 9014

DESCRIPTION

Adjustable height pendant fixture with unique counterweight system available in black chrome or glossy white. The dancing cotton strands are available in eight colours. Unexpected play of light and shadow, Swing creates spaces both intimate and glamorous.

GENERAL SPECIFICATIONS

Installation	Ceiling
Ambient	Indoor
IP	20

MATERIALS

Body	Steel
Shade	Cotton

FINISHES

Steel	Black Chrome, Glossy White
Cotton	White, Black, Red, Green, Light Grey, Violet, Brown, Flax

GENERAL DIMENSIONS

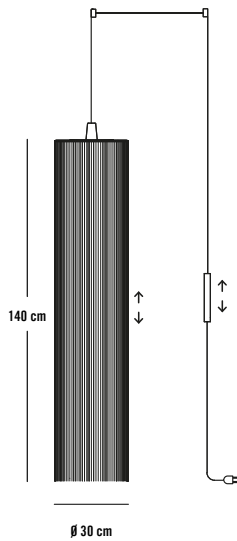

ELECTRICAL CHARACTERISTICS

Safety class	Class I
Light source	LED
LED type	E27
Rated input wattage	1 x 7W
Colour Temperature	2700K
AC Voltage	220-240v
Frequency	50-60Hz
Dimmer <i>(Subject to dimmable light bulb*)</i>	TRIAC <i>(phase cut)</i> DALI on request

* Light bulb not included



FINISHES

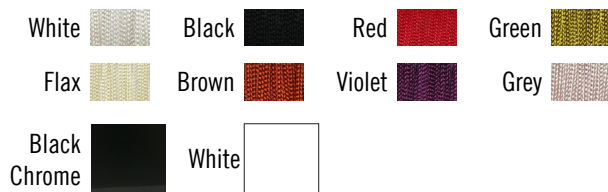

DIMENSIONS AND PACKAGING

Body	Ø30x140cm
Cable length	8.5m
Box dimension	40x40x40cm
Box volume	0.192m ³
Box weight	5.7g

MAINTENANCE

Clean with a smooth cloth. Do not use ammonia, solvents or abrasive cleaning products.

IMAGEN



* Modelos 9004 y 9014

DESCRIPCIÓN

Lámpara de suspensión regulable en altura a través de un contrapeso metálico acabado en cromo negro o pintado blanco brillante. Compuesta por hilos en tejido de algodón en ocho colores. Imprevisibles juegos de luces y sombras, Swing crea ambientes de glamour e intimidad.

ESPECIFICACIONES GENERALES

Montaje	Techo
Ambiente	Interior
IP	20

MATERIALES

Cuerpo	Acero
Pantalla	Hilo de algodón

ACABADOS

Acero	Cromo Negro, Blanco brillante
Hilo algodón	Blanco, Negro, Rojo, Verde, Gris claro, Violeta, Marrón, Crema

COTAS GENERALES

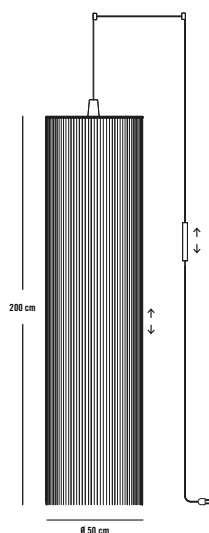

CARACTERÍSTICAS ELÉCTRICAS

Clase de aislamiento	Clase I
Tipo fuente de luz	LED
Tipo LED	E27
Potencia total	1 x 10W
Temperatura de color	2700K
Voltaje AC	220-240v
Frecuencia	50-60Hz
Regulación (<i>Sujeto a bombilla* regulable</i>)	TRIAC (<i> corte de fase</i>) DALI bajo pedido

* Bombilla no incluida



ACABADOS

Blanco	Negro	Rojo	Verde
Crema	Marrón	Violeta	Gris
Cromo Negro	Blanco		

MANTENIMIENTO

Limpiar con un paño suave. No utilizar productos amoniacales, disolventes o abrasivos.

DIMENSIONES Y EMBALAJE

Cuerpo	Ø50x200cm
Longitud de cable	8,5m
Medida bulto	60x60x50cm
Volumen bulto	0,180m ³
Peso bulto	13,3kg

IMAGE



* Modelos 9004 y 9014

DESCRIPTION

Adjustable height pendant fixture with unique counterweight system available in black chrome or glossy white. The dancing cotton strands are available in eight colours. Unexpected play of light and shadow, Swing creates spaces both intimate and glamorous.

GENERAL SPECIFICATIONS

Installation	Ceiling
Ambient	Indoor
IP	20

MATERIALS

Body	Steel
Shade	Cotton

FINISHES

Steel	Black Chrome, Glossy White
Cotton	White, Black, Red, Green, Light Grey, Violet, Brown, Flax

GENERAL DIMENSIONS

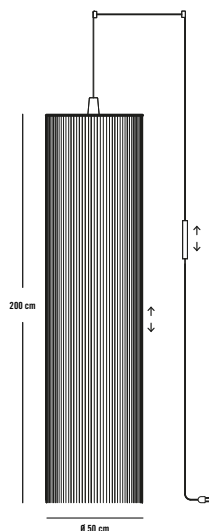

ELECTRICAL CHARACTERISTICS

Safety class	Class I
Light source	LED
LED type	E27
Rated input wattage	1 x 10W
Colour Temperature	2700K
AC Voltage	220-240v
Frequency	50-60Hz
Dimmer <i>(Subject to dimmable light bulb*)</i>	TRIAC <i>(phase cut)</i> DALI on request

* Light bulb not included



FINISHES

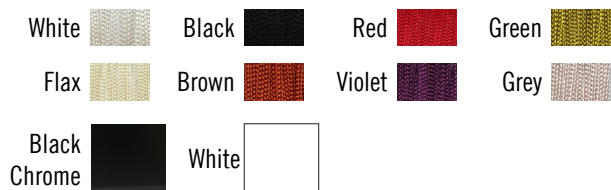

DIMENSIONS AND PACKAGING

Body	∅50x200cm
Cable length	8.5m
Box dimension	60x60x50cm
Box volume	0.180m ³
Box weight	13.3kg

MAINTENANCE

Clean with a smooth cloth. Do not use ammonia, solvents or abrasive cleaning products.

IMAGEN



DESCRIPCIÓN

Lámpara de suspensión regulable en altura a través de un contrapeso metálico acabado en cromo negro o pintado blanco brillante. Compuesta por hilos en tejido de algodón en ocho colores. Imprevisibles juegos de luces y sombras, Swing crea ambientes de glamour e intimidad.

ESPECIFICACIONES GENERALES

Montaje	Techo
Ambiente	Interior
IP	20

MATERIALES

Cuerpo	Acero
Pantalla	Hilo de algodón

ACABADOS

Acero	Cromo Negro, Blanco brillante
Hilo algodón	Blanco, Negro, Rojo, Verde, Gris claro, Violeta, Marrón, Crema

COTAS GENERALES

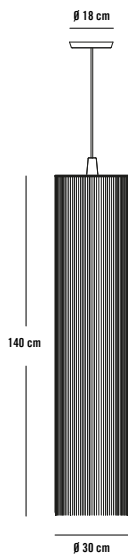

CARACTERÍSTICAS ELÉCTRICAS

Clase de aislamiento	Clase I
Tipo fuente de luz	LED
Tipo LED	E27
Potencia total	1 x 7W
Temperatura de color	2700K
Voltaje AC	220-240v
Frecuencia	50-60Hz
Regulación (<i>Sujeto a bombilla* regulable</i>)	TRIAC (<i>corde de fase</i>) DALI bajo pedido

* Bombilla no incluida



ACABADOS



DIMENSIONES Y EMBALAJE

Cuerpo	Ø30x135cm
Longitud de cable	2m
Peso neto	3,5kg
Medida bulto	40x40x40cm
Volumen bulto	0,064m ³
Peso bulto	5kg

MANTENIMIENTO

Limpiar con un paño suave. No utilizar productos amoniacales, disolventes o abrasivos.

IMAGE



DESCRIPTION

Adjustable height pendant fixture with unique counterweight system available in black chrome or glossy white. The dancing cotton strands are available in eight colours. Unexpected play of light and shadow, Swing creates spaces both intimate and glamorous.

GENERAL SPECIFICATIONS

Installation	Ceiling
Ambient	Indoor
IP	20

MATERIALS

Body	Steel
Shade	Cotton

FINISHES

Steel	Black Chrome, Glossy White
Cotton	White, Black, Red, Green, Light Grey, Violet, Brown, Flax

GENERAL DIMENSIONS

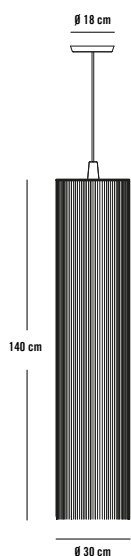

ELECTRICAL CHARACTERISTICS

Safety class	Class I
Light source	LED
LED type	E27
Rated input wattage	1 x 7W
Colour Temperature	2700K
AC Voltage	220-240v
Frequency	50-60Hz
Dimmer <i>(Subject to dimmable light bulb*)</i>	TRIAC <i>(phase cut)</i> DALI on request

* Light bulb not included



FINISHES

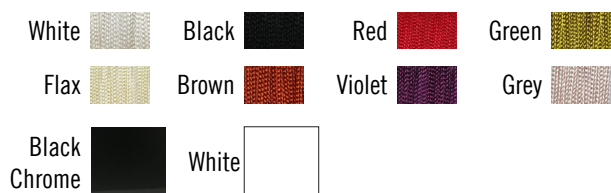

DIMENSIONS AND PACKAGING

Body	Ø30x135cm
Cable length	2m
Net weight	3.5kg
Box dimension	40x40x40cm
Box volume	0.064m ³
Box weight	5kg

MAINTENANCE

Clean with a smooth cloth. Do not use ammonia, solvents or abrasive cleaning products.

IMAGEN



DESCRIPCIÓN

Lámpara de suspensión regulable en altura a través de un contrapeso metálico acabado en cromo negro o pintado blanco brillante. Compuesta por hilos en tejido de algodón en ocho colores. Imprevisibles juegos de luces y sombras, Swing crea ambientes de glamour e intimidad.

ESPECIFICACIONES GENERALES

Montaje	Techo
Ambiente	Interior
IP	20

MATERIALES

Cuerpo	Acero
Pantalla	Hilo de algodón

ACABADOS

Acero	Cromo Negro, Blanco brillante
Hilo algodón	Blanco, Negro, Rojo, Verde, Gris claro, Violeta, Marrón, Crema

COTAS GENERALES

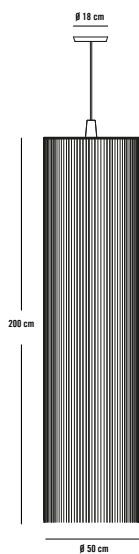

CARACTERÍSTICAS ELÉCTRICAS

Clase de aislamiento	Clase I
Tipo fuente de luz	LED
Tipo LED	E27
Potencia total	1 x 7W
Temperatura de color	2700K
Voltaje AC	220-240v
Frecuencia	50-60Hz
Regulación (<i>Sujeto a bombilla* regulable</i>)	TRIAC (<i>corde de fase</i>) DALI bajo pedido

* Bombilla no incluida



ACABADOS



DIMENSIONES Y EMBALAJE

Cuerpo	Ø50x200cm
Longitud de cable	2m
Peso neto	3,5kg
Medida bulto	60x60x50cm
Volumen bulto	0.064m³
Peso bulto	8,6kg

MANTENIMIENTO

Limpiar con un paño suave. No utilizar productos amoniacales, disolventes o abrasivos.

IMAGE



DESCRIPTION

Adjustable height pendant fixture with unique counterweight system available in black chrome or glossy white. The dancing cotton strands are available in eight colours. Unexpected play of light and shadow, Swing creates spaces both intimate and glamorous.

GENERAL SPECIFICATIONS

Installation	Ceiling
Ambient	Indoor
IP	20

MATERIALS

Body	Steel
Shade	Cotton

FINISHES

Steel	Black Chrome, Glossy White
Cotton	White, Black, Red, Green, Light Grey, Violet, Brown, Flax

GENERAL DIMENSIONS

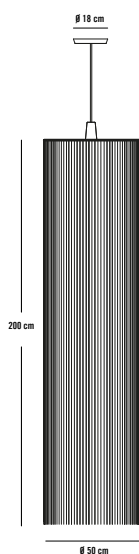

ELECTRICAL CHARACTERISTICS

Safety class	Class I
Light source	LED
LED type	E27
Rated input wattage	1 x 7W
Colour Temperature	2700K
AC Voltage	220-240v
Frequency	50-60Hz
Dimmer <i>(Subject to dimmable light bulb*)</i>	TRIAC <i>(phase cut)</i> DALI on request

* Light bulb not included



FINISHES

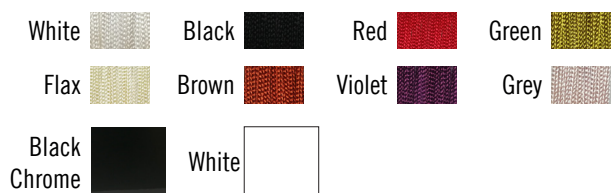

DIMENSIONS AND PACKAGING

Body	Ø50x200cm
Cable length	2m
Net weight	3.5kg
Box dimension	60x60x50cm
Box volume	0.064m³
Box weight	8.6kg

MAINTENANCE

Clean with a smooth cloth. Do not use ammonia, solvents or abrasive cleaning products.

IMAGEN



DESCRIPCIÓN

Aplicador de pared regulable en altura a través de un contrapeso metálico acabado en cromo negro o pintado blanco brillante. Compuesta por hilos en tejido de algodón en ocho colores. Imprevisibles juegos de luces y sombras, Swing crea ambientes de glamour e intimidad.

ESPECIFICACIONES GENERALES

Montaje	Pared
Ambiente	Interior
IP	20

MATERIALES

Cuerpo	Acero
Pantalla	Hilo de algodón

ACABADOS

Acero	Cromo Negro, Blanco brillante, Latón
Hilo algodón	Blanco, Negro, Rojo, Verde, Gris claro, Violeta, Marrón, Crema

COTAS GENERALES

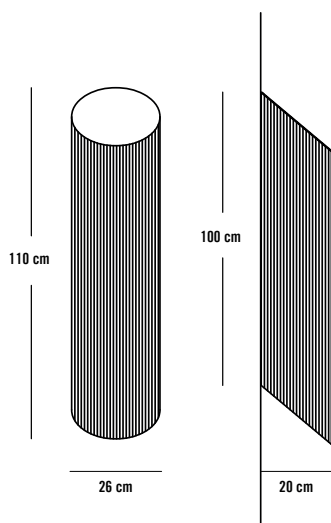

CARACTERÍSTICAS ELÉCTRICAS

Clase de aislamiento	Clase I
Tipo fuente de luz	LED
Tipo LED	Placa de LED
Potencia total	18W
Lumens	1800lm
Temperatura de color	2700K
Voltaje AC	220-240
Frecuencia	50-60Hz
Corriente nominal	500mA
CRI	90
Driver	Incluido
Regulación	TRIAC (corte de fase) bajo pedido DALI bajo pedido



ACABADOS

Blanco	Negro	Rojo	Verde
Crema	Marrón	Violeta	Gris
Cromo Negro	Blanco	Latón	

MANTENIMIENTO

Limpiar con un paño suave. No utilizar productos amoniacales, disolventes o abrasivos.

DIMENSIONES Y EMBALAJE

Cuerpo	26x110x20cm
Peso neto	2.4kg
Medida bulto	40x40x25cm
Volumen bulto	0.040m ³
Peso bulto	4.25kg

IMAGE



DESCRIPTION

Wall light available in black chrome or glossy white. The dancing cotton strands are available in eight colours. Unexpected play of light and shadow, Swing creates spaces both intimate and glamorous.

GENERAL SPECIFICATIONS

Installation	Wall
Ambient	Indoor
IP	20

MATERIALS

Body	Steel
Shade	Cotton

FINISHES

Steel	Black Chrome, Glossy White, Brass
Cotton	White, Black, Red, Green, Light Grey, Violet, Brown, Flax

GENERAL DIMENSIONS

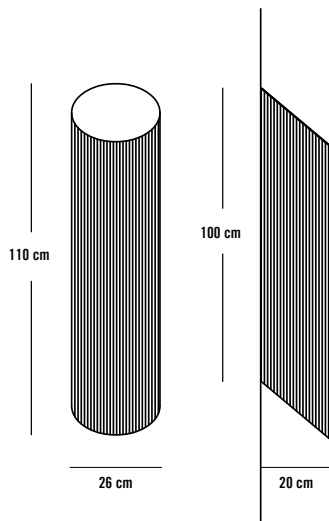

ELECTRICAL CHARACTERISTICS

Safety class	Class I
Light source	LED
LED type	Integrated LED
Rated input wattage	18W
Luminous flux	1800lm
Colour Temperature	2700K
AC Voltage	220-240
Frequency	50-60Hz
Operating current	500mA
CRI	90
Driver	Included
Dimmer	TRIAC (phase cut) on request DALI on request



FINISHES

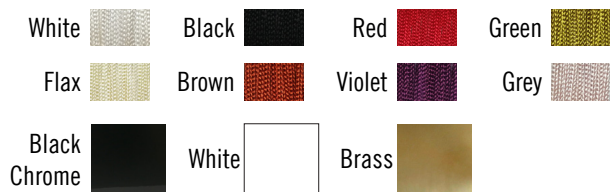

DIMENSIONS AND PACKAGING

Body	26x110x20cm
Net weight	2.4kg
Box dimension	40x40x25cm
Box volume	0.040m ³
Box weight	4.25kg

MAINTENANCE

Clean with a smooth cloth. Do not use ammonia, solvents or abrasive cleaning products.